



PRIMA COLLECTION

2020



INDICE POSATE / Cutlery Index

Sea.....	3
Easy.....	4
Erika.....	5
Reims.....	6
Marina Vibrato.....	7
Versilia.....	8
Flavia.....	9
Cardiff Vibrato.....	10
Derby.....	11
Marina.....	12
Monaco.....	13
Dinner.....	14
Bell.....	15
Maiorca.....	16
One.....	17
Galles.....	18
Milano.....	19
Venezia.....	20
Dover.....	21
Eat.....	22
Villa.....	24
Ponza.....	26
Daisy.....	28
Country.....	29
Princess.....	30
Accessori.....	32

POSATE
CUTLERY







size 1:1

SEA R02

inox 18/0
UDV 120 pz
mm 1,5

**SOLO VENDITA MASTER
ONLY MASTER SELLING**

Master 120 pz
120 pcs master box





	cod. master	Euro master	Euro 1 pcs
	0M001	89,58	0,75
	0M002	89,58	0,75
	0M0L3	126,26	1,06
	0M007	65,88	0,55



**SOLO VENDITA MASTER
ONLY MASTER SELLING**







Chiave
(master 24 pz)
(24 pcs master box)

	cod. chiave	cm cutlery	Euro chiave
x3 	HW301	19,7	2,84
x3 	HW302	20,0	2,84
x2 	HW2L3	21,3	2,78
x6 	HW607	13,0	3,96





EASY 124

inox 18/0
UDV 12 pz
mm 1,5

Confezione 12 pz
12 pcs box

	cod.	Euro 1 pcs
	00001	0,80
	00002	0,80
	000L3	0,84
	00007	0,56
	00017	0,56







		Valva cod. valva	Euro valva
x24		0\$Q01	17,80
x24		0\$Q02	17,80
x12		0\$HL3*	23,44
x36		0\$B07	17,80
x36		0\$B17	17,80

*lamin. 3,8 mm

SOLO VENDITA MASTER
ONLY MASTER SELLING



Chiave
(master 24 pz)
(24 pcs master box)

	cod. chiave	cm cutlery	Euro chiave
x3	 EW301	19,0	2,96
x3	 EW302	19,0	2,96
x2	 EW2L3	20,9	2,32
x6	 EW607	13,7	3,82
x6	 EW617	13,6	3,82

ERIKA

118





inox 18/0

UDV 120 pz

mm 1,5

SOLO VENDITA MASTER
ONLY MASTER SELLING

Master 120 pz
120 pcs master box





	cod. master	Euro master	Euro 1 pcs
	0M001	104,00	0.87
	0M002	104,00	0.87
	0M0L3	217,92	1.82
	0M007	73,48	0.61



SOLO VENDITA MASTER
ONLY MASTER SELLING



Chiave
(master 24 pz)
(24 pcs master box)

	cod. chiave	cm cutlery	Euro chiave
x3 	BW301	18,5	3,24
x3 	BW302	18,6	3,24
x2 	BW2L3	21,0	4,32
x6 	BW607	13,0	4,16

REIMS

R14

inox 18/0





UDV 120 pz

mm 1,8

SOLO VENDITA MASTER
ONLY MASTER SELLING

Master 120 pz

120 pcs master box

	cod. master	Euro master	Euro 1 pcs
	0M001	104,00	0,87
	0M002	104,00	0,87
	0M0L3	126,26	1,05
	0M007	70,82	0.59







SOLO VENDITA MASTER
ONLY MASTER SELLING



Chiave

(master 24 pz)

(24 pcs master box)

	cod. chiave	cm cutlery	Euro chiave
x3 	LW301	18,8	3,20
x3 	LW302	18,8	3,20
x2 	LW2L3	20,5	2,78
x6 	LW607	13,0	4,18







MARINA VIBRATO

117

inox 18/0
UDV 240 pz
mm 1,8

SOLO VENDITA MASTER
ONLY MASTER SELLING

Master 240 pz
240 pcs master box







	cod. master	Euro master	Euro 1 pcs
	1M001	207,08	0,86
	1M002	207,08	0,86
	1M0L3	212,68	0,89
	1M004	171,08	0,71
	1M005	171,08	0,71
	1M007	123,08	0,5
	1M008	109,16	0,45



SOLO VENDITA MASTER
ONLY MASTER SELLING



Chiave
(master 24 pz)
(24 pcs master box)

	cod. chiave	cm cutlery	Euro chiave
x3 	KW301	19,7	3,22
x3 	KW302	20,0	3,22
x2 	KW2L3	21,0	2,42
x3 	KW304	18,5	2,72
x3 	KW305	18,7	2,72
x6 	KW607	13,0	3,70
x6 	KW608	11,2	3,40

VERSILIA

102





inox 18/0

UDV 12 pz

mm 1,5

Confezione 12 pz

12 pcs box

	cod.	Euro 1 pcs
	00001	0,88
	00002	0,88
	000L3	2,52
	00007	0,56







SOLO VENDITA MASTER
ONLY MASTER SELLING



Chiave

(master 24 pz)

(24 pcs master box)

	cod. chiave	cm cutlery	Euro chiave
x3	 EW301	19,7	3,40
x3	 EW302	19,2	3,40
x2	 EW2L3	22,0	5,56
x6	 EW607	12,5	4,08

FLAVIA

109





inox 18/0

UDV 12 pz

mm 1,5

Confezione 12 pz

12 pcs box





	cod.	Euro 1 pcs
	00001	0,88
	00002	0,88
	000L3	2,52
	00007	0,56



SOLO VENDITA MASTER
ONLY MASTER SELLING



Chiave
(master 24 pz)
(24 pcs master box)

	cod. chiave	cm cutlery	Euro chiave
x3 	EW301	19,5	3,40
x3 	EW302	19,5	3,40
x2 	EW2L3	22,2	5,56
x6 	EW607	12,5	4,08

CARDIFF VIBRATO

133

inox 18/0





UDV 120 pz

mm 1,5

SOLO VENDITA MASTER
ONLY MASTER SELLING

Master 120 pz

120 pcs master box

	cod. master	Euro master	Euro 1 pcs
	1M001	108,96	0,91
	1M002	108,96	0,91
	1M0L3	195,10	1,63
	1M007	73,48	0,61







SOLO VENDITA MASTER
ONLY MASTER SELLING



Chiave

(master 24 pz)

(24 pcs master box)

	cod. chiave	cm cutlery	Euro chiave
x3 	KW301	19,6	3,32
x3 	KW302	19,3	3,32
x2 	KW2L3	21,2	3,92
x6 	KW607	14,0	4,32

DERBY

R03









inox 18/0

UDV 120 pz

mm 2,0

SOLO VENDITA MASTER
ONLY MASTER SELLING

Master 120 pz
120 pcs master box









	cod. master	Euro master	Euro 1 pcs
	0M001	108,48	0,90
	0M002	108,48	0,90
	0M0L3	179,14	1,49
	0M004	101,24	0,84
	0M005	101,24	0,84
	0M0L6	169,72	1,41
	0M007	73,02	0,61
	0M008	63,68	0,53



SOLO VENDITA MASTER
ONLY MASTER SELLING



Chiave
(master 24 pz)
(24 pcs master box)

	cod. chiave	cm cutlery	Euro chiave
x3 	FW301	19,6	3,30
x3 	FW302	19,6	3,30
x2 	FW2L3	22,0	3,66
x3 	FW304	17,8	3,20
x3 	FW305	17,7	3,20
x2 	FW2L6	19,4	3,44
x6 	FW607	14,1	4,28
x6 	FW608	11,5	3,84

MARINA

117

inox 18/0

UDV 240 pz









mm 1,8



**SOLO VENDITA MASTER
ONLY MASTER SELLING**

Master 240 pz

240 pcs master box

	cod. master	Euro master	Euro 1 pcs
	0M001	240,70	1,00
	0M002	240,70	1,00
	0M0L3	436,54	1,82
	0M004	223,88	0,93
	0M005	223,88	0,93
	0M007	145,48	0,61
	0M008	128,70	0,54
	0M017	162,30	0,68

**SOLO VENDITA MASTER
ONLY MASTER SELLING**



Chiave

(master 24 pz)

(24 pcs master box)

	cod. chiave	cm cutlery	Euro chiave
x3	HW301	19,7	3,62
x3	HW302	20,0	3,62
x2	HW2L3	21,0	4,32
x3	HW304	18,5	3,38
x3	HW305	18,7	3,38
x6	HW607	13,0	4,28
x6	HW608	11,2	3,84
x6	HW617	14,7	4,68

MONACO

174

inox 18/0











UDV 120 pz

mm 1,8



**SOLO VENDITA MASTER
ONLY MASTER SELLING**











Master 120 pz
120 pcs master box

	cod. master	Euro master	Euro 1 pcs
	0M001	121,62	1,01
	0M002	121,62	1,01
	0M0L3	222,98	1,86
	0M004	117,78	0,98
	0M005	117,78	0,98
	0M0L6	214,22	1,79
	0M007	98,82	0,82
	0M008	84,26	0,70
	0M017	98,82	0,82
	0M036	120,84	1,00

**SOLO VENDITA MASTER
ONLY MASTER SELLING**



Chiave
(master 24 pz)
(24 pcs master box)

	cod. chiave	cm cutlery	Euro chiave
x3 	GW301	19,6	3,64
x3 	GW302	19,6	3,64
x2 	GW2L3	20,8	4,32
x3 	GW304	18,5	3,54
x3 	GW305	18,5	3,54
x2 	GW2L6	19,7	4,16
x6 	GW607	13,0	5,52
x6 	GW608	11,3	4,80
x6 	GW617	15,0	5,52
x6 	GW636	21,0	6,64

DINNER

R04





inox 18/0

UDV 120 pz

mm 2,0

SOLO VENDITA MASTER
ONLY MASTER SELLING

Master 120 pz
120 pcs master box





	cod. master	Euro master	Euro 1 pcs
	0M001	124,62	1,04
	0M002	124,62	1,04
	0M0L3	186,02	1,55
	0M007	77,52	0,65



SOLO VENDITA MASTER
ONLY MASTER SELLING



Chiave
(master 24 pz)
(24 pcs master box)

	cod. chiave	cm cutlery	Euro chiave
x3 	HW301	20,0	3,74
x3 	HW302	20,0	3,74
x2 	HW2L3	22,0	3,78
x6 	HW607	14,2	4,48

BELL

144





inox 18/0

UDV 120 pz

mm 1,5

SOLO VENDITA MASTER
ONLY MASTER SELLING

Master 120 pz
120 pcs master box





	cod. master	Euro master	Euro 1 pcs
	0M001	124,40	1,04
	0M002	124,40	1,04
	0M0L3	220,44	1,84
	0M007	86,14	0,72



SOLO VENDITA MASTER
ONLY MASTER SELLING



Chiave
(master 24 pz)
(24 pcs master box)

	cod. chiave	cm cutlery	Euro chiave
x3 	FW301	19,6	3,74
x3 	FW302	19,5	3,74
x2 	FW2L3	21,3	4,32
x6 	FW607	14,0	5,00





MAIORCA

R06

inox 18/0
UDV 120 pz
mm 2,0

**SOLO VENDITA MASTER
ONLY MASTER SELLING**

Master 120 pz
120 pcs master box





	cod. master	Euro master	Euro 1 pcs
	0M001	132,64	1,11
	0M002	132,64	1,11
	0M0L3	230,80	1,88
	0M007	85,64	0,70



**SOLO VENDITA MASTER
ONLY MASTER SELLING**



Chiave
(master 24 pz)
(24 pcs master box)





	cod. chiave	cm cutlery	Euro chiave
x3 	LW301	21,0	3,96
x3 	LW302	21,0	3,96
x2 	LW2L3	22,0	4,42
x6 	LW607	15,2	4,94

ONE 185

inox 18/0
UDV 120 pz
mm 2,0

**SOLO VENDITA MASTER
ONLY MASTER SELLING**

Master 120 pz
120 pcs master box





	cod. master	Euro master	Euro 1 pcs
	0M001	141,90	1,18
	0M002	141,90	1,18
	0M0L3	250,84	2,09
	0M007	88,68	0,72



**SOLO VENDITA MASTER
ONLY MASTER SELLING**



Chiave
(master 24 pz)
(24 pcs master box)

	cod. chiave	cm cutlery	Euro chiave
x3 	CW301	18,9	4,16
x3 	CW302	18,6	4,16
x2 	CW2L3	22,1	4,80
x6 	CW607	13,5	5,00

GALLES

089

inox 18/10









UDV 12 pz

mm 1,8





Confezione 12 pz

12 pcs box



	cod.	Euro 1 pcs
	X0001	1,20
	X0002	1,20
	X00L3	2,40
	X0005	1,20
	X00L6	2,18
	X0007	0,78
	X0008	0,66
	X0017	0,88









Sfuso
single pieces

	cod.	cm cutlery	Euro 1 pcs
	X0010	26,8	11,22
	X0011	21,8	4,08
	X0012	21,6	4,08
	X0020	23,4	4,64

SOLO VENDITA MASTER
ONLY MASTER SELLING



Chiave
(master 24 pz)
(24 pcs master box)

	cod. chiave	cm cutlery	Euro chiave
x3	 GW301	21,0	4,28
x3	 GW302	21,0	4,28
x2	 GW2L3	22,0	5,20
x3	 GW305	17,6	4,12
x2	 GW2L6	19,6	4,82
x6	 GW607	15,2	5,28
x6	 GW608	11,6	4,42
x6	 GW617	15,2	5,74





MILANO

R10

inox 18/10
UDV 120 pz
mm 2,2

SOLO VENDITA MASTER
ONLY MASTER SELLING

Master 120 pz
120 pcs master box





	cod. master	Euro master	Euro 1 pcs
	0M001	171,18	1,43
	0M002	171,18	1,43
	0M0L3	230,80	1,92
	0M007	125,96	1,05



SOLO VENDITA MASTER
ONLY MASTER SELLING



Chiave
(master 24 pz)
(24 pcs master box)

	cod. chiave	cm cutlery	Euro chiave
x3 	CW301	19,5	4,94
x3 	CW302	19,5	4,94
x2 	CW2L3	21,5	4,42
x6 	CW607	14,0	6,92

VENEZIA

R08

inox 18/10





UDV 120 pz

mm 2,2

SOLO VENDITA MASTER
ONLY MASTER SELLING

Master 120 pz

120 pcs master box

	cod. master	Euro master	Euro 1 pcs
	0M001	173,92	1,45
	0M002	173,92	1,45
	0M0L3	230,80	1,92
	0M007	116,50	0,97







SOLO VENDITA MASTER
ONLY MASTER SELLING



Chiave

(master 24 pz)

(24 pcs master box)

	cod. chiave	cm cutlery	Euro chiave
x3 	CW301	19,5	4,94
x3 	CW302	19,5	4,94
x2 	CW2L3	21,5	4,42
x6 	CW607	13,3	6,48











DOVER

R11

inox 18/0
UDV 120 pz
mm 2,5

SOLO VENDITA MASTER
ONLY MASTER SELLING

Master 120 pz
120 pcs master box











	cod. master	Euro master	Euro 1 pcs
	0M001	213,34	1,77
	0M002	213,34	1,77
	0M003	403,52	3,36
	0M067	392,30	3,27
	0M004	145,80	1,22
	0M005	145,80	1,22
	0M006	376,90	3,14
	0M007	98,60	0,85
	0M008	91,48	0,76
	0M017	98,60	0,83
	0M036	148,80	1,24



SOLO VENDITA MASTER
ONLY MASTER SELLING









Chiave
(master 24 pz)
(24 pcs master box)

	cod. chiave	cm cutlery	Euro chiave
x3 	BW301	20,2	5,92
x3 	BW302	20,5	5,92
x2 	BW203	23,5	7,42
x2 	BW267	22,5	7,22
x3 	BW304	17,8	4,24
x3 	BW305	17,7	4,24
x2 	BW206	21,5	6,86
x6 	BW607	14,0	5,60
x6 	BW608	12,2	5,16
x6 	BW617	15,1	5,60
x6 	BW636	21,0	8,02

EAT 257







inox 18/10
UDV 12 pz
mm 1,8

Confezione 12 pz
12 pcs box

	cod.	Euro 1 pcs
	00001	1,32
	00002	1,32
	00003	2,74
	00007	0,82
	00008	0,74
	00017	0,98



Valva

	cod. valva	Euro valva
x12 	0\$H01	17,36
x12 	0\$H02	17,36
x6 	0\$603	17,36
x20 	0\$U07	17,36
x18 	0\$\$17	17,36
x6 	0\$651	17,36

*lamin. 3,8 mm







SOLO VENDITA MASTER
ONLY MASTER SELLING



Chiave

(master 24 pz)

(24 pcs master box)

	cod. chiave	cm cutlery	Euro chiave
x3 	LW301	20,1	4,54
x3 	LW302	19,9	4,54
x2 	LW203	21,8	6,08
x6 	LW607	14,2	5,52
x6 	LW608	11,5	5,02
x6 	LW617	15,5	6,50















VILLA 255

inox 18/10
UDV 12 pz
mm 2,5

Confezione 12 pz
12 pcs box













	cod.	Euro 1 pcs
	00001	2,08
	00002	2,08
	00003	4,10
	00004	2,06
	00005	2,06
	00006	4,04
	00007	1,24
	00008	1,04
	00017	1,30
	00029	2,08

SOLO VENDITA MASTER
ONLY MASTER SELLING



Chiave
(master 24 pz)
(24 pcs master box)

	cod. chiave	cm cutlery	Euro chiave
x3	 CW301	20,9	6,80
x3	 CW302	20,8	6,80
x2	 CW203	23,0	8,80
x3	 CW304	18,0	6,74
x3	 CW305	18,0	6,74
x2	 CW206	21,0	8,68
x6	 CW607	14,5	7,98
x6	 CW608	11,1	6,86
x6	 CW617	15,6	8,44
x3	 CW329	20,0	6,80



PONZA

256

inox 18/10











UDV 12 pz

mm 2,5





Confezione 12 pz

12 pcs box



	cod.	Euro 1 pcs
	00001	2,28
	00002	2,28
	00003	4,10
	00004	2,26
	00005	2,26
	00006	4,08
	00007	1,26
	00008	0,96
	00017	1,20
	00029	2,16

Sfuso
single pieces

	cod.	Euro 1 pcs
	00010	13,76
	00011	5,96
	00012	5,96
	00013	7,80











SOLO VENDITA MASTER
ONLY MASTER SELLING



Chiave

(master 24 pz)

(24 pcs master box)

	cod. chiave	cm cutlery	Euro chiave
x3	 GW301	20,3	7,42
x3	 GW302	20,1	7,42
x2	 GW203	22,8	8,80
x3	 GW304	18,0	7,36
x3	 GW305	18,0	7,36
x2	 GW206	21,0	8,76
x6	 GW607	14,0	8,10
x6	 GW608	11,7	6,38
x6	 GW617	15,4	7,84
x3	 GW329	20,5	7,06







DAISY

2G_07091

inox / ABS
SET 24 PCS



cod.	colour	Euro
A	 BLACK	26,64
B	 WHITE	26,64
C	 BLUE	26,64
D	 SAND	26,64







COUNTRY

2F_07091

inox / ABS

SET 24 PCS



cod.	colour	Euro
A	 WOOD	28,90
B	 BLACK	28,90
C	 GREY	28,90
D	 GREEN	28,90



PRINCESS



2C_07091

inox / stainless steel

SET 24 PCS

NEW



cod.	colour	Euro
R	 SUN	48,40
S	 AMBER	49,50
T	 CARBON	56,90





ACCESSORI ACCESSORIES

Coltello bistecca

Steak knife

cod. 74600...

cod.	descriz.	Euro pack.
PEU	scatola bianca 12 pz / <i>12 pcs set white box</i>	11,26
6EU	blister 6 pz / <i>blister 6 pcs</i>	6,30



NEW

Coltello bistecca punta tonda

Steak knife rounded tip

cod. 74600...

cod.	descriz.	Euro pack.
PFU	scatola bianca 12 pz / <i>12 pcs set white box</i>	11,70
6 FU	blister 6 pz / <i>blister 6 pcs</i>	6,98



Coltello tavola

Table knife

cod. 74600...

cod.	descriz.	Euro pack.
PEK	scatola bianca 12 pz / <i>12 pcs set white box</i>	7,08
6EK	blister 6 pz / <i>blister 6 pcs</i>	3,98



Forbice da cucina
Kitchen scissor
cod. 58174620
Euro 3,06



NEW

Cavatappi
Corkscrew
cod. 50916200
Euro 6,16



NEW

Cavatappi professionale
Professional corkscrew
cod. 58174300
Euro 2,40



OLIERE PRIMA

5717

acciaio inox, vetro / stainless steel, glass

sistema salvagoccia / non-leaking system.

articoli venduti in scatola litografata / articles are packed in lithographed box.

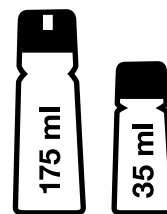

NEW

Set oliera 5 posti / 5 pcs cruet set
cod. 57175205

ml	cm	Euro
175 / 35	14x11x20	16,70



Set oliera 2 posti / 2 pcs cruet set
cod. 57175002

ml	cm	Euro
175	12x6,5x17	11,98



Set sale, pepe e stuzzicadenti / Salt, pepper and toothpick set
cod. 57177303

ml	cm	Euro
35	10x8,3x11,5	9,30



Set sale e pepe / Salt and pepper set
cod. 57177202

ml	cm	Euro
35	10x5,3x11,5	5,90



Formaggera / Cheese bowl
cod. 57173000

ml	cm	Euro
200	11x10x12,5	15,30



RICAMBI / SPARE PARTS:

vetro per olio e aceto / oil and vinegar glass - **cod. 97200151**

vetro per sale e pepe / salt and pepper glass - **cod. 97200152**

vetro per stuzzicadenti / toothpick glass - **cod. 97200153**

vetro per formaggera / cheese bowl glass - **cod. 97200150**

tappo per olio / cup for oil and vinegar glass - **cod. 97200154**

tappo per sale e pepe / salt and pepper glass - **cod. 97200155**



INDICE COTTURA / Cookware Index

Ecoline.....	37
Inox Plus.....	40
Comfort.....	42
First.....	46
Pentola Pressione First.....	47
Pop.....	48
Smart.....	50
Spatole / Spatula.....	51

COTTURA COOKWARE





ECOLINE R500



MANICO IN ACCIAIO

STAINLESS STEEL HANDLE



INOX PLUS R600



MANICO IN ACCIAIO CON FONDO
TERMODIFFUSORE

*STAINLESS STEEL HANDLE WITH
THERMAL DIFFUSION BOTTOM*



COMFORT R650



MANICO IN BACHELITE CON
FONDO TERMODIFFUSORE

*BAKELITE HANDLE WITH
THERMAL-DIFFUSION BOTTOM*



PRIMA COLLECTION

**COTTURA
COOKWARE**

ECOLINE R500

Acciaio Inox 18/0 - 18/0 Stainless Steel

made in Italy 

NICKEL FREE



INDUZIONE
INDUCTION



GAS
GAS



CERAMICO
CERAMIC



ALOGENO
HALOGEN



ELETTRICO
ELECTRIC

Pentola / Pot cod. R50003..

Ø cm	h cm	Lt	Master	cm Master	kg Master	Euro
16	12	2,1	6	30x20x46	2,76	12,80
18	13	2,8	6	31x33,5x45	3,23	14,68
20	14,5	3,8	6	31x34x46	2,76	18,22
22	14,7	5	4	33x32,5x44	2,86	21,20
24	17,1	6,5	4	38x30x55	3,28	22,94
26	17,3	8,5	4	37x29x57	3,81	26,36
28	18	10,5	2	37x29x57	2,96	30,90
30	24	16,7	-	-	-	50,08
32	26,2	20,7	-	-	-	61,32



Casseruola / Casserole cod. R50005..

Ø cm	h cm	Lt	Master	cm Master	kg Master	Euro
16	7,5	1,3	6	24x34x23	2,53	11,82
18	8	1,8	6	24x34x23	2,54	12,80
20	9,4	2,4	6	20x30x46	2,85	14,14
22	10,5	3,5	4	46x30x18	2,40	16,10
24	11,4	4,8	4	33x30x34	2,70	17,44
26	13	5,4	4	33x30x33	2,95	18,54
28	14	8	4	37x29x57	4,06	26,36
30	14,5	9,8	-	-	-	42,34
32	16	12,4	-	-	-	55,06



Tegame / Roasting pan cod. R50023..

Ø cm	h cm	Lt	Master	cm Master	kg Master	Euro
24	4,5	2	6	24x34x23	3,28	16,44
28	5	3,2	6	32x32x30	3,76	21,96



Cuoci asparagi / *Asparagus pot*
cod. R5000816

Ø cm	h cm	Lt	Euro
16	20,5	4	54,74



Casseruola ovale con coperchio / *Oval casserole with lid*
cod. R50016..

cm	h cm	Lt	Euro
28	9,5	3,6	32,14
32	11	5,8	43,82



Colabrodo / *Colander*
cod. R50067..

cm	Euro
14	10,50
16	11,56



Teglia rettangolare / *Rectangular roasting pan*
cod. R50004..

cm	h cm	Lt	Euro
25x18	5	2	14,00
30x22	5,5	3,4	16,12
35x26	6	5	21,66
40x28	6,2	6,5	26,30
45x32	7,9	10	43,72



Coperchio per teglia rettangolare / *Lid for rectangular roasting pan*
cod. R50028..

cm	Euro
25x18	10,82
30x22	12,74
35x26	15,70
40x28	18,56



Bollilatte / *Milkpot*
cod. R5006012

Ø cm	h cm	Lt	Master	cm Master	kg Master	Euro
12	9	0,9	6	16x27x22	1,4	9,72



Cuoci Prima / *Cuoci Prima pot*
cod. R5087720

Ø cm	h cm	Lt	Euro
20	12,4	3,7	30,80



Casseruola 1 manico / *Saucepan*
cod. R50006..

Ø cm	h cm	Lt	Master	cm Master	kg Master	Euro
12	5	0,5	6	24x13x28	1,01	8,82
16	7,5	1,3	6	23x23x34	1,74	10,82



Padella / *Frying pan*
cod. R50025..

Ø cm	h cm	Lt	Master	cm Master	kg Master	Euro
24	4,5	2	12	46x30x18	5,68	17,66
28	5	3,2	6	30x44,5x32,5	3,50	24,16



Cestello vapore / *Steaming basket*
cod. R5009822

Ø cm	h cm	Master	cm Master	kg Master	Euro
22	10,5	4	31x20x46	2,33	16,90



Coperchio / *Lid*
cod. R50030..

Ø cm	Master	cm Master	kg Master	Euro
16	12	26x23x33,5	1,8	6,30
18	12	26x23x36	2,11	6,50
20	12	31x20x46	2,41	6,86
22	12	31x20x46	2,94	7,28
24	12	31,5x33,5x45	3,72	7,72
26	12	31x34x45,5	4,24	8,72
28	12	31x34x45,5	5,22	10,48
30	12	32x44x32	5,54	14,42
32	12	32x44x32	5,87	15,24



INOX PLUS R600

Acciaio Inox 18/0 - 18/0 Stainless Steel

con fondo termodiffusore / with thermal diffusion bottom

made in Italy 

NICKEL FREE



INDUZIONE
INDUCTION



GAS
GAS



CERAMICO
CERAMIC



ALOGENO
HALOGEN



ELETTRICO
ELECTRIC

Pentola / Pot cod. R60003..

Ø cm	h cm	Lt	Euro
16	12	2,1	17,68
18	13	2,8	20,04
20	14,5	3,8	22,42
22	14,7	5	25,04
24	17,1	6,5	26,54
26	17,3	8,5	30,66
28	18	10,5	35,96



Casseruola / Casserole cod. R60005..

Ø cm	h cm	Lt	Euro
16	7,5	1,3	16,24
18	8	1,8	18,28
20	9,4	2,4	20,64
22	10,5	3,5	23,02
24	11,4	4,8	24,48
26	13	5,4	27,52
28	14	8	33,00



Tegame / Roasting pan cod. R60023..

Ø cm	h cm	Lt	Euro
24	4,5	2	21,50
28	5	3,2	28,58



Casseruola 1 manico / Saucepan cod. R60006..

Ø cm	h cm	Lt	Euro
12	5	0,5	12,40
16	7,5	1,3	15,52



Bollilatte / *Milkpot*
cod. R6006012

Ø cm	h cm	Lt	Euro
12	9	0,9	15,64



Padella / *Frying pan*
cod. R60025..

Ø cm	h cm	Lt	Euro
24	4,5	2	22,42
28	5	3,2	30,94



Cestello vapore / *Steaming basket*
cod. R5009822

Ø cm	h cm	Euro
22	10,5	16,90



Coperchio / *Lid*
cod. R50030..

Ø cm	Master	cm Master	kg Master	Euro
16	12	26x23x33,5	1,8	6,30
18	12	26x23x36	2,11	6,50
20	12	31x20x46	2,41	6,86
22	12	31x20x46	2,94	7,28
24	12	31,5x33,5x45	3,72	7,72
26	12	31x34x45,5	4,24	8,72
28	12	31x34x45,5	5,22	10,48
30	12	32x44x32	5,54	14,42
32	12	32x44x32	5,87	15,24



COMFORT R650

Acciaio Inox 18/0 - 18/0 Stainless Steel

con manico in bachelite e fondo termodiffusore / with bakelite handle and thermal diffusion bottom

made in Italy 

NICKEL FREE



INDUZIONE
INDUCTION



GAS
GAS



CERAMICO
CERAMIC



ALOGENO
HALOGEN



ELETTRICO
ELECTRIC

Pentola / Pot cod. R65003..

Ø cm	h cm	Lt	Euro
16	12	2,1	21,72
18	13	2,8	23,92
20	14,5	3,8	26,20
22	14,7	5	29,20
24	17,1	6,5	30,34
26	17,3	8,5	36,30
28	18	10,5	42,52



Casseruola / Casserole cod. R65005..

Ø cm	h cm	Lt	Euro
16	7,5	1,3	19,96
18	8	1,8	22,06
20	9,4	2,4	24,58
22	10,5	3,5	26,88
24	11,4	4,8	28,46
26	13	5,4	33,00
28	14	8	39,40



Tegame / Roasting pan cod. R65023..

Ø cm	h cm	Lt	Euro
24	4,5	2	26,16
28	5	3,2	35,30



Casseruola 1 manico / Saucepan cod. R65006..

Ø cm	h cm	Lt	Euro
12	5	0,5	15,88
16	7,5	1,3	19,24



Bollilatte / Milkpot
cod. R6506012

Ø cm	h cm	Lt	Euro
12	9	0,9	17,52



Padella / Frying pan
cod. R65025..

Ø cm	h cm	Lt	Euro
24	4,5	2	27,02
28	5	3,2	37,52



Cestello vapore / Steaming basket
cod. R6509822

Ø cm	h cm	Euro
22	10,5	21,96



Coperchio / Lid
cod. R65031..

Ø cm	Euro
16	7,62
18	7,82
20	8,18
22	9,06
24	9,28
26	10,04
28	11,90



1. Tutti gli articoli sono prodotti in Italia.
2. Tre serie complete:
Ecoline: il miglior prezzo.
Comfort: serie elegante con manici in bachelite.
Inox plus: ottimo rapporto qualità-prezzo.
3. Tutti gli articoli sono prodotti con acciai certificati e idonei al contatto alimentare secondo decreto legislativo DL 108 dt 25.01.92 e Dir. CEE 1935/2004 e 89/109.
4. Adatta a tutti i tipi di cucina, induzione compresa.
5. Bordo rinforzato.
6. Le maniglie e i manici sono ergonomici e in bachelite anticalore.
7. Packaging informativo dedicato.
8. Nickel Free.

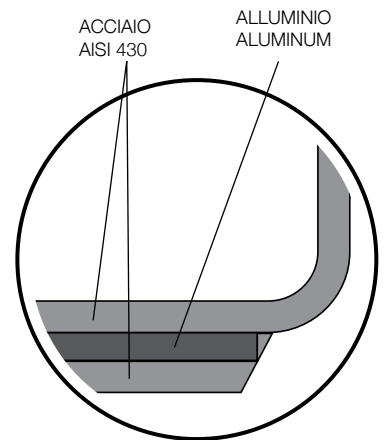

Fondo termodiffusore
*Thermal diffusion
bottom*

1. *100% Made in Italy.*
2. *Three complete series.*
Ecoline: *best value for money of the series.*
Comfort: *Elegance series with Bakelite handles.*
Inox plus: *excellent price-quality ratio.*
3. *All stainless steel used in mass production is in conformity with DL 108 dated 25.01.92 & CEE 1935/20014 and 89/109 law.*
4. *Suitable for all kind of cooktops, including induction.*
5. *Reinforced edge.*
6. *Bakelite ergonomic handles and knobs, made to avoid heat contact.*
7. *Nice and dedicated packaging.*
8. *Nickel Free.*



Maniglia in bachelite
Bakelite handles.



Bordo rinforzato
Reinforced edge.



FIRST R800

acciaio inox 18/10 - 18/10 stainless steel

fondo 3 strati / 3 layers bottom.

articoli venduti in scatola litografata / articles are packed in lithographed box.



INDUZIONE
INDUCTION



GAS
GAS



CERAMICO
CERAMIC



ALOGENO
HALOGEN



ELETTRICO
ELECTRIC

NEW

Pentola bassa con coperchio / *Low pot with lid*
cod. R800V3..

Ø cm	Lt	Euro
20	3,1	24,36
24	6,3	29,00
28	11	35,46



Casseruola con coperchio / *Casserole with lid*
cod. R800V1..

Ø cm	Lt	Euro
20	2,5	22,80
24	4,5	27,10



Casseruola 1 manico / *Saucepan*
cod. R8000616

Ø cm	Lt	Euro
16	1,5	19,00



Bollilatte / *Milk pot*
cod. R8006014

Ø cm	Lt	Euro
14	1,5	27,60



FIRST R800

Acciaio Inox 18/0 - 18/0 Stainless Steel

4 Sistemi di Sicurezza / 4 Safety Systems

INDUZIONE / INDUCTION



INDUZIONE
INDUCTION



GAS
GAS



CERAMICO
CERAMIC



ALOGENO
HALOGEN



ELETTRICO
ELECTRIC

NEW

pentola a pressione Tradizionale Lt 5
Traditional pressure cooker Lt 5

R8005105

Ø cm 20

Euro 34,00



pentola a pressione Tradizionale Lt 7
Traditional pressure cooker Lt 7

R8005107

Ø cm 20

Euro 36,50



RICAMBI / SPARE PARTS:

coperchio completo / lid for pressure cooker - cod. R800500



POP 3790

Alluminio stampato in 2,5 mm con rivestimento antiaderente Whitford Xylan 2 strati.
2,5 mm pressed aluminum with Whitford Xylan 2 layers non-stick coating.

Fondo HOLE INDUCTION.
Bottom: HOLE INDUCTION.

Manici in bakelite atermica.
Handle with "stay-cool" bakelite material.



INDUZIONE
INDUCTION



GAS
GAS



CERAMICO
CERAMIC



ALOGENO
HALOGEN



ELETTRICO
ELECTRIC

casseruola alta con coperchio / deep casserole with lid
cod. 3790V1..

Ø cm	h cm	Lt	Euro
20	7,7	2,4	20,20
24	10,5	4,8	27,90



casseruola 1 manico / saucepan
37900616
Ø cm 16 h cm 6,7 Lt 1,3
Euro 14,10



wok con coperchio / wok with lid
37909528
Ø cm 28 h cm 7,67 Lt 4,1
Euro 28,98



crepiere / crepe frying pan
37904525
Ø cm 25 h cm 1,61 Lt 0,7
Euro 13,60



bistecchiera / grill pan
 37905326
 cm 26 h cm 3,98 Lt 2,3
Euro 21,98



padella / frying pan
 cod. 379025..

Ø cm	Lt	Euro
20	1,1	12,10
22	1,3	13,98
24	1,8	15,30
26	1,9	16,80
28	2,8	18,50
30	3,0	20,20



padella con manico e maniglia / frying pan
 cod. 37902532
 Ø cm 32 h cm 5,39 Lt 3,9
Euro 22,90



SMART

5217

nylon PA66 - max 210°C

consigliati per padelle antiaderenti / recommended for non-stick frying pans.

NEW

Cucchiaio / *Serving spoon*

cod. 52170000

Euro 2,48



Cucchiaio forato / *Perforated spoon*

cod. 52170100

Euro 2,48



Mestolo / *Ladle*

cod. 52172000

Euro 2,48



Schiumarola / *Skimmer*

cod. 52174000

Euro 2,48



Servispaghetti / *Spaghetti server*

cod. 52177000

Euro 2,48



Spatola / *Spatula*

cod. 52176000

Euro 2,48



Spatola forata / *Perforated spatula*

cod. 52173000

Euro 2,48



Frusta / *Whisk*

cod. 52171800

Euro 2,48



Pinza / *Chef tong*

cod. 52179100

Euro 2,48



SPATOLE

SPATULA

Spatola dritta
Slimline spatula

cod.	cm	Euro
78500410	16	5,34
78500412	20	5,66
78500413	23,5	6,10
78500414	29	6,64



Spatola dritta con piega
Turner round and flexible spatula

cod.	cm	Euro
78500420	18	7,98
78500421	20	8,32
78500422	25	8,76



Spatola per cucinare
Grill scraper spatula

Cod.	cm	Euro
78500430	7,5	6,22
78500431	10	7,44
78500432	12,5	7,88
78500433	15	8,54



98900673



PRIMA COLLECTION

2020



PINTI INOX S.p.A. Via Antonini, 87 - 25068 Sarezzo (BS) Italia
Tel. +39 030 89351 - Fax +39 030 8935250 - www.pinti.it - pintinox@pinti.it

PINTI INOX GMBH DEUTSCHLAND - Römerstraße 91 - 73066 Uhingen
Tel +49 07161 93343-0 - Fax +49 07161 352789 - www.pinti.de - info@pinti.de